



Algerian Turkish Injection Manufacturing

altiminvest.com

**CATALOGUE DE
PRODUITS**







Irrigation par aspersion

Aspersion avec verouillage en plastique

Désignation



• Application :

Tubes PEHD et accessoires pour l'irrigation par aspersion des parcelles agricoles de 1/3 à 2/3 d'hectare

• Caractéristiques des tubes :

- *Matière : PEHD
- *Conditionnement : en barre de 06 m
- *Assemblage : par emboîtement avec joint verrouillé
- *Pression de service : 06 bars

Diamètre des buses (mm)	Pression de Service					
	2 Bar		2,5 Bar		3 Bar	
	Débit (m ³ /h)	Portée (m)	Débit (m ³ /h)	Portée (m)	Débit (m ³ /h)	Portée (m)
2,3-3,8	1,05	12	1,2	12,5	1,3	12,8
3,0-4,2	1,55	13	1,7	13,5	1,85	14,5

• Avantages du Kit :

- *Légèreté et facilité de mise en oeuvre
- *Longévité et durabilité
- *Étanchéité parfaite grâce au système d'emboîtement à joint
- *Faible perte de charge et résistance à la pression
- *Possibilité de plusieurs configurations
- *Pression de service : 03 bars

Schéma d'Installation

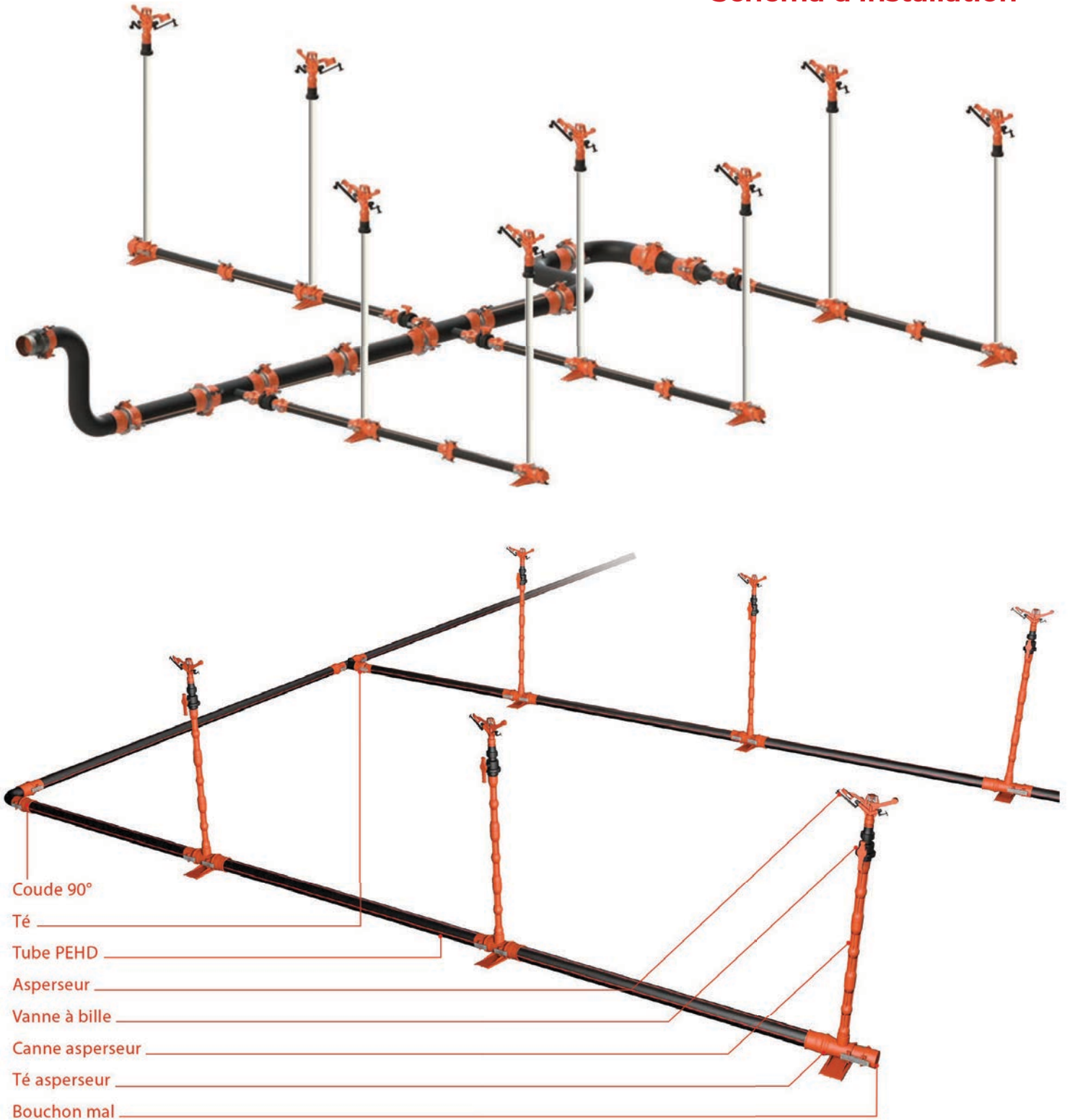

Irrigation par aspersion

Aspersion avec verouillage en plastique

• Tuyaux - Tubes



Code produit	Diamètre	
	mm	pouces
050-005-601	50	1 ½"
063-005-601	63	2"
075-005-601	75	2 ½"
090-005-601	90	3"
110-005-601	110	4"
125-005-601	125	4 ½"
140-005-601	140	5"
160-005-601	160	6"

• Tuyaux - Tubes



Code produit	Diamètre	
	mm	pouces
050-005-602	50	1 ½"
063-005-602	63	2"
075-005-602	75	2 ½"
090-005-602	90	3"
110-005-602	110	4"
125-005-602	125	4 ½"
140-005-602	140	5"
160-005-602	160	6"

• Attachement de tubes/ Abot



Code produit	Diamètre	
	mm	pouces
050-001-607	50	1 ½"
063-001-607	63	2"
075-001-607	75	2 ½"
090-001-607	90	3"
110-002-607	110	4"

• Valve de ligne sphérique



Code produit	Diamètre	
	mm	pouces
050-000-612	50	1 ½"
063-000-612	63	2"
075-000-612	75	2 ½"
090-000-612	90	3"
110-000-612	110	4"

• Coude



Code produit	Diamètre	
	mm	pouces
050-000-608	50	1 ½"
063-000-608	63	2"
075-000-608	75	2 ½"
090-000-608	90	3"
110-000-608	110	4"
125-000-608	125	4 ½"
140-000-608	140	5"
160-000-608	160	6"

• Réduction



Code produit	Diamètre	
	mm	pouces
063-050-665	63 x 50	2" x 1 ½"
075-050-666	75 x 50	2 ½" x 1 ½"
075-063-667	75 x 63	2 ½" x 2"
090-050-668	90 x 50	3" x 1 ½"
090-063-669	90 x 63	3" x 2"
090-075-670	90 x 75	3" x 2 ½"
110-075-671	110 x 75	4" x 2 ½"
110-090-672	110 x 90	4" x 3"
125-075-673	125 x 75	4 ½" x 2 ½"
125-090-674	125 x 90	4 ½" x 3"
125-110-675	125 x 110	4 ½" x 4"
140-090-677	140 x 90	5" x 3"
140-110-678	140 x 110	5" x 4"
140-125-679	140 x 125	5" x 4 ½"
160-110-682	160 x 110	6" x 4"
160-125-683	160 x 125	6" x 4 ½"
160-140-684	160 x 140	6" x 5"

• «S» (Tube changement de niveau)



Code produit	Diamètre	
	mm	pouces
075-000-613	75	2 ½"
090-000-613	90	3"
110-000-613	110	4"

• Joint raccord



Code produit	Diamètre	
	mm	pouces
050-000-509	50	1 ½"
063-000-509	63	2"
075-000-509	75	2 ½"
090-000-509	90	3"
110-000-509	110	4"
125-000-509	125	4 ½"
140-000-509	140	5"
160-000-509	160	6"

• Té



Code produit	Diamètre	
	mm	pouces
050-050-621	50 x 50	1 ½" x 1 ½"
063-063-623	63 x 63	2" x 2"
075-050-624	75 x 50	2 ½" x 1 ½"
075-063-625	75 x 63	2 ½" x 2"
075-075-626	75 x 75	2 ½" x 2 ½"
090-050-627	90 x 50	3" x 1 ½"
090-063-628	90 x 63	3" x 2"
090-075-629	90 x 75	3" x 2 ½"
090-090-630	90 x 90	3" x 3"
110-050-631	110 x 50	4" x 1 ½"
110-063-631	110 x 63	4" x 2"
110-075-631	110 x 75	4" x 2 ½"
110-090-632	110 x 90	4" x 3"
110-110-633	110 x 110	4" x 4"
125-050-634	125 x 50	4 ½" x 1 ½"
125-063-634	125 x 63	4 ½" x 2"
125-075-634	125 x 75	4 ½" x 2 ½"
125-090-635	125 x 90	4 ½" x 3"
125-110-636	125 x 110	4 ½" x 4"
125-125-637	125 x 125	4 ½" x 4 ½"
140-075-638	140 x 75	5" x 2 ½"
140-090-639	140 x 90	5" x 3"
140-110-640	140 x 110	5" x 4"
140-125-641	140 x 125	5" x 4 ½"
140-140-642	140 x 140	5" x 5"
160-075-643	160 x 75	6" x 2 ½"
160-090-644	160 x 90	6" x 3"
160-110-645	160 x 110	6" x 4"
160-125-646	160 x 125	6" x 4 ½"
160-140-647	160 x 140	6" x 5"
160-160-648	160 x 160	6" x 6"

• Croix



Code produit	Diamètre	
	mm	pouces
050-050-642	50 x 50	1 ½" x 1 ½"
063-063-644	63 x 63	2" x 2"
075-050-645	75 x 50	2 ½" x 1 ½"
075-063-646	75 x 63	2 ½" x 2"
075-075-647	75 x 75	2 ½" x 2 ½"
090-050-648	90 x 50	3" x 1 ½"
090-063-649	90 x 63	3" x 2"
090-075-650	90 x 75	3" x 2 ½"
090-090-651	90 x 90	3" x 3"
110-050-652	110 x 50	4" x 1 ½"
110-063-652	110 x 63	4" x 2"
110-075-652	110 x 75	4" x 2 ½"
110-090-653	110 x 90	4" x 3"
110-110-654	110 x 110	4" x 4"
125-050-655	125 x 50	4 ½" x 1 ½"
125-063-655	125 x 63	4 ½" x 2"
125-075-655	125 x 75	4 ½" x 2 ½"
125-090-656	125 x 90	4 ½" x 3"
125-110-657	125 x 110	4 ½" x 4"
125-125-658	125 x 125	4 ½" x 4 ½"
140-075-659	140 x 75	5" x 2 ½"
140-090-660	140 x 90	5" x 3"
140-110-661	140 x 110	5" x 4"
140-125-662	140 x 125	5" x 4 ½"
140-140-663	140 x 140	5" x 5"
160-075-664	160 x 75	6" x 2 ½"
160-090-665	160 x 90	6" x 3"
160-110-666	160 x 110	6" x 4"
160-125-667	160 x 125	6" x 4 ½"
160-140-668	160 x 140	6" x 5"
160-160-669	160 x 160	6" x 6"

Irrigation par aspersion

Aspersion avec verouillage en plastique

• Tête/Accouplement - Mâle



Code produit	Diamètre	
	mm	pouces
050-000-603	50	1 ½"
063-000-603	63	2"
075-000-603	75	2 ½"
090-000-603	90	3"
110-000-603	110	4"
125-000-603	125	4 ½"
140-000-603	140	5"
160-000-603	160	6"

• Tête/Accouplement - Femelle



Code produit	Diamètre	
	mm	pouces
050-000-504	50	1 ½"
063-000-504	63	2"
075-000-504	75	2 ½"
090-000-504	90	3"
110-000-504	110	4"
125-000-504	125	4 ½"
140-000-504	140	5"
160-000-504	160	6"

• Embout mâle



Code produit	Diamètre	
	mm	pouces
050-000-605	50	1 ½"
063-000-605	63	2"
075-000-605	75	2 ½"
090-000-605	90	3"
110-000-605	110	4"
125-000-605	125	4 ½"
140-000-605	140	5"
160-000-605	160	6"

• Embout femelle



Code produit	Diamètre	
	mm	pouces
050-000-506	50	1 ½"
063-000-506	63	2"
075-000-506	75	2 ½"
090-000-506	90	3"
110-000-506	110	4"
125-000-506	125	4 ½"
140-000-506	140	5"
160-000-506	160	6"

• Connecteur pompe en métal - Mâle

	Code produit		Diamètre		Quantité	Type de carton
			mm	pouces		
					Carton	
	063-000-614		63	2"	60	B-1
	075-000-614		75	2 ½"	30	B-1
	090-000-614		90	3"	24	B-1
	110-000-614		110	4"	12	B-1
	125-000-614		125	4 ½"	8	B-1
	140-000-614		140	5"	4	B-1
	160-000-614		160	6"	4	B-1

• Connecteur pompe en métal - Femelle

	Code produit		Diamètre		Quantité	Type de carton
			mm	pouces		
					Carton	
	063-000-515		63	2"	80	B-1
	075-000-515		75	2 ½"	36	B-1
	090-000-515		90	3"	30	B-1
	110-000-515		110	4"	18	B-1
	125-000-515		125	4 ½"	8	B-1
	140-000-515		140	5"	5	B-1
	160-000-515		160	6"	5	B-1

• Connecteur pompe en plastique- Mâle

	Code produit		Diamètre		Quantité	Type de carton
			mm	pouces		
					Carton	
	050-000-616		50	2 ½"	100	B-1
	063-000-616		63	2"	60	B-1
	075-000-616		75	2 ½"	36	B-1
	090-000-616		90	3"	24	B-1

• Connecteur pompe en plastique - Femelle

	Code produit		Diamètre		Quantité	Type de carton
			mm	pouces		
					Carton	
	050-000-517		50	1 ½"	210	B-1
	063-000-517		63	2"	120	B-1
	075-000-517		75	2 ½"	52	B-1
	090-000-517		90	3"	36	B-1

Irrigation par aspersion

Aspersion avec verouillage en plastique

• Asperseur- 1610 SK



Code produit	Diamètre		Quantité	Type de carton
	mm	pouces		
025-000-016-02	32	3/4	60	B-1

• Asperseur - 1615



Code produit	Diamètre		Quantité	Type de carton
	mm	pouces		
025-000-013	20	1/2	175	B-1

• Asperseur - 1615 K



Code produit	Diamètre		Quantité	Type de carton
	mm	pouces		
025-000-014	20	1/2	150	B-1

• Valve sphérique



Code produit	Diamètre		Quantité	Type de Sachet
	mm	pouces		
032-032-004	32	1	100	S-3

• Tube Ascendant/Allonge - PP

	Couleur du produit	Longueur	Code produit	Diameter		Quantité/ sachet	Type de Sachet
		cm		mm	pouces	Sachet	
	Orange	25 M x M	032-032-125	32 x 32	1" x 1"	100	S-2
Orange	25 M x F	032-032-225	32 x 32	1" x 1"	100	S-2	
Orange	35 M x M	032-032-135	32 x 32	1" x 1"	100	S-3	
Orange	35 M x F	032-032-235	32 x 32	1" x 1"	100	S-3	
Orange	50 M x M	032-032-150	32 x 32	1" x 1"	100	S-4	
Orange	50 M x F	032-032-250	32 x 32	1" x 1"	100	S-4	

• Mamelon

	Code produit		Diamètre		Quantité/ sachet		Type de Carton
			mm	pouces	Sachet	Carton	
	032-032-003	32x32	1"x1"	150	450	B-1	

• Manchon de réduction

	Code produit		Diamètre		Quantité/ sachet		Type de Carton
			mm	pouces	Sachet	Carton	
	032-020-001	32 x 20	1" x ½"	150	450	B-1	
032-025-002	32 x 25	1" x ¾"	150	450	B-1		

• Manchon

	Code produit		Diamètre		Quantité/ sachet		Type de Carton
			mm	pouces	Sachet	Carton	
	032-032-005	32x32	1"x1"	150	450	B-1	

• Adaptateur

	Code produit		Diamètre		Quantité/ sachet		Type de Carton
			mm	pouces	Sachet	Carton	
	040-032-006	40 x 32	1" ½ x 1"	150	450	B-1	

• Adaptateur

	Code produit		Diamètre		Quantité/ sachet		Type de Carton
			mm	pouces	Sachet	Carton	
	032-025-001	32	1" x ¾"	150	450	B-1	

Irrigation par aspersion

Aspersion avec verouillage en plastique

• Mini manchon de ressort avec vis



Code produit	Diamètre		Quantité/ sachet		Type de Carton
	mm	pouces	Sachet	Carton	
020-000-007	20 x 20	½ x ½	100	500	B-1
025-000-007	25 x 25	¾" x ¾"	100	500	B-1

• Abot type Croix



Code produit	Diamètre		Quantité/ sachet		Type de Carton
	mm	pouces	Sachet	Carton	
020-000-008	32 x 20 x 20 x 20	1"x½"x½"x½"	100	400	B-2

• Abot type Croix mâle – Mâle filetage



Code produit	Diamètre		Quantité/ sachet		Type de Carton
	mm	pouces	Sachet	Carton	
020-000-009	32x25x20x20	1"x¾"x½"x½"	100	400	B-2

• Abot type Croix mâle – Femelle filetage



Code produit	Diamètre		Quantité/ sachet		Type de Carton
	mm	pouces	Sachet	Carton	
020-000-011	32x32x20x20	1"x1"x½"x½"	100	300	B-2
025-000-011	32x32x25x25	1"x1"x¾"x¾"	100	300	B-2

• Barre de fer



Code produit	Diamètre		Length
	mm	cm	
020-000-010	8	120	

• Tuyau d'égouttement interne (400 mètres/rouleau)

		Code produit	Code produit	Diameter	Epaisseur	Flux	Espace entre goutteurs	Longueur du rouleau
		2,0 L/h	4,0 L/h	mm	mm	L/h	cm	m
		116-09-20-020	116-09-40-020	16	0,9	2,0/4,0	20	400
		116-09-20-025	116-09-40-025				25	
		116-09-20-033	116-09-40-033				33	
		116-09-20-040	116-09-40-040				40	
		116-09-20-050	116-09-40-050				50	
		116-10-20-020	116-10-40-020		1,0		20	
		116-10-20-025	116-10-40-025				25	
		116-10-20-033	116-10-40-033				33	
		116-10-20-040	116-10-40-040				40	
		116-10-20-050	116-10-40-050				50	

• Tubes d'irrigation Goutte à Goutte pour goutteurs externes

		Code produit	Diameter	Epaisseur	longueur du rouleau
			mm	mm	m
		116-09-00-090	16	0,9	400
		116-10-00-100	16	1,0	400
		120-12-00-120	20	1,2	300

Irrigation Goutte à Goutte

Tuyaux d'irrigation par égouttement plat (gaine)

• Ø 17 mm Tuyaux d'irrigation par égouttement plat (gaines) (Tapes)



Code produit	Code produit	Code produit	Diameter	Epaisseur	Flux	Espace entre goutteurs
1,0 L/h	1,6 L/h	2,2 L/h	mm	mil/mm	L/h	cm
017-06-10-010	017-06-16-010	017-06-22-010	17	6 mil 0,150 mm	1,0 1,6 2,2	10
017-06-10-015	017-06-16-015	017-06-22-015				15
017-06-10-020	017-06-16-020	017-06-22-020				20
017-06-10-025	017-06-16-025	017-06-22-025				25
017-06-10-030	017-06-16-030	017-06-22-030				30
017-06-10-040	017-06-16-040	017-06-22-040		40		
017-06-10-050	017-06-16-050	017-06-22-050		50		
017-08-10-010	017-08-16-010	017-08-22-010		10		
017-08-10-015	017-08-16-015	017-08-22-015		15		
017-08-10-020	017-08-16-020	017-08-22-020		20		
017-08-10-025	017-08-16-025	017-08-22-025		25		
017-08-10-030	017-08-16-030	017-08-22-030		30		
017-08-10-040	017-08-16-040	017-08-22-040		40		
017-08-10-050	017-08-16-050	017-08-22-050		50		
017-10-10-010	017-10-16-010	017-10-22-010		10		
017-10-10-015	017-10-16-015	017-10-22-015		15		
017-10-10-020	017-10-16-020	017-10-22-020		20		
017-10-10-025	017-10-16-025	017-10-22-025		25		
017-10-10-030	017-10-16-030	017-10-22-030		30		
017-10-10-040	017-10-16-040	017-10-22-040		40		
017-10-10-050	017-10-16-050	017-10-22-050		50		

• Ø 22 mm Tuyaux d'irrigation par égouttement plat (gaines)



Code produit	Code produit	Code produit	Diameter	Epaisseur	Flux	Espace entre goutteurs
1,0 L/h	1,6 L/h	2,2 L/h	mm	mil/mm	L/h	cm
022-08-10-010	022-08-16-010	022-08-22-010	22	8 mil 0,200 mm	1,0 1,6 2,2	10
022-08-10-015	022-08-16-015	022-08-22-015				15
022-08-10-020	022-08-16-020	022-08-22-020				20
022-08-10-025	022-08-16-025	022-08-22-025				25
022-08-10-030	022-08-16-030	022-08-22-030				30
022-08-10-040	022-08-16-040	022-08-22-040		40		
022-08-10-050	022-08-16-050	022-08-22-050		50		
022-10-10-010	022-10-16-010	022-10-22-010		10		
022-10-10-015	022-10-16-015	022-10-22-015		15		
022-10-10-020	022-10-16-020	022-10-22-020		20		
022-10-10-025	022-10-16-025	022-10-22-025		25		
022-10-10-030	022-10-16-030	022-10-22-030		30		
022-10-10-040	022-10-16-040	022-10-22-040		40		
022-10-10-050	022-10-16-050	022-10-22-050		50		
022-12-10-010	022-12-16-010	022-12-22-010		10		
022-12-10-015	022-12-16-015	022-12-22-015		15		
022-12-10-020	022-12-16-020	022-12-22-020		20		
022-12-10-025	022-12-16-025	022-12-22-025		25		
022-12-10-030	022-12-16-030	022-12-22-030		30		
022-12-10-040	022-12-16-040	022-12-22-040		40		
022-12-10-050	022-12-16-050	022-12-22-050		50		

Irrigation Goutte à Goutte

Tuyaux d'irrigation par égouttement plat (gaine)

• Ø 25 mm Tuyaux d'irrigation par égouttement plat (gaines)



Code produit	Code produit	Code produit	Diameter	Epaisseur	Flux	Espace entre goutteurs
1,0 L/h	1,6 L/h	2,2 L/h	mm	mil/mm	L/h	cm
025-10-10-010	025-10-16-010	025-10-22-010	25	10 mil 0,250 mm	1,0 1,6 2,2	10
025-10-10-015	025-10-16-015	025-10-22-015				15
025-10-10-020	025-10-16-020	025-10-22-020				20
025-10-10-025	025-10-16-025	025-10-22-025				25
025-10-10-030	025-10-16-030	025-10-22-030				30
025-10-10-040	025-10-16-040	025-10-22-040				40
025-10-10-050	025-10-16-050	025-10-22-050				50
025-12-10-010	025-12-16-010	025-12-22-010				10
025-12-10-015	025-12-16-015	025-12-22-015				15
025-12-10-020	025-12-16-020	025-12-22-020				20
025-12-10-025	025-12-16-025	025-12-22-025		25		
025-12-10-030	025-12-16-030	025-12-22-030		30		
025-12-10-040	025-12-16-040	025-12-22-040		40		
025-12-10-050	025-12-16-050	025-12-22-050		50		
025-16-10-010	025-16-16-010	025-16-22-010		10		
025-16-10-015	025-16-16-015	025-16-22-015		15		
025-16-10-020	025-16-16-020	025-16-22-020		20		
025-16-10-025	025-16-16-025	025-16-22-025		25		
025-16-10-030	025-16-16-030	025-16-22-030		30		
025-16-10-040	025-16-16-040	025-16-22-040		40		
025-16-10-050	025-16-16-050	025-16-22-050		50		

• Ø 28 mm Tuyaux d'irrigation par égouttement plat (gaines)



Code produit	Code produit	Code produit	Diameter	Epaisseur	Flux	Espace entre goutteurs
1,0 L/h	1,6 L/h	2,2 L/h	mm	mil/mm	L/h	cm
028-14-10-010	028-14-16-010	028-14-22-010	28	14 mil 0,350 mm	1,0 1,6 2,2	10
028-14-10-015	028-14-16-015	028-14-22-015				15
028-14-10-020	028-14-16-020	028-14-22-020				20
028-14-10-025	028-14-16-025	028-14-22-025				25
028-14-10-030	028-14-16-030	028-14-22-030				30
028-14-10-040	028-14-16-040	028-14-22-040				40
028-14-10-050	028-14-16-050	028-14-22-050				50
028-16-10-010	028-16-16-010	028-16-22-010				10
028-16-10-015	028-16-16-015	028-16-22-015				15
028-16-10-020	028-16-16-020	028-16-22-020				20
028-16-10-025	028-16-16-025	028-16-22-025		25		
028-16-10-030	028-16-16-030	028-16-22-030		30		
028-16-10-040	028-16-16-040	028-16-22-040		40		
028-16-10-050	028-16-16-050	028-16-22-050		50		

Irrigation Goutte à Goutte

Tubes Ronds d'irrigation Goutte à Goutte

• Vannettes cannelées



Code du produit	Diamètre	Quantité/sachet		Type de carton
	mm	Sachet	Carton	
100-16-08-001	16 x 16	125	625	B-1
100-20-08-002	20 x 16	125	500	B-1
100-20-08-003	20 x 20	125	500	B-1

• Mini valve avec prise d'étanchéité



Code du produit	Diamètre	Quantité/sachet		Type de carton
	mm	Sachet	Carton	
100-16-09-001	16 x 16	125	625	B-1
100-20-09-002	20 x 16	125	500	B-1
100-20-09-003	20 x 20	125	500	B-1

• Mini-vannes à ruban avec sortie de joint



Code du produit	Diamètre	Quantité/sachet		Type de carton
	mm	Sachet	Carton	
100-16-10-001	16 x 17	100	500	B-1
100-20-10-002	20 x 17	100	400	B-1
100-20-10-003	20 x 22	100	400	B-1

• Vannette gaine/ fileté



Code du produit	Diamètre	Quantité/sachet		Type de carton
	mm	Sachet	Carton	
100-16-11-001	16 x 17	100	500	B-1
100-20-11-002	20 x 17	100	400	B-1
100-20-11-003	20 x 22	100	400	B-1

• Mini vannes à queue d'aronde vissée- Mâle



Code du produit	Diamètre	Quantité/sachet		Type de carton
	mm	Sachet	Carton	
100-16-12-001	1/2 x 16	100	500	B-1
100-16-12-002	3/4 x 16	100	500	B-1
100-20-12-003	1/2 x 20	100	400	B-1
100-20-12-004	3/4 x 20	100	400	B-1

• Mini-vannes à vis - Mâle



Code du produit	Diamètre	Quantité/sachet		Type de carton
	mm	Sachet	Carton	
100-17-13-001	1/2 x 17	80	400	B-1
100-17-13-002	3/4 x 17	80	400	B-1
100-22-13-003	1/2 x 22	-	-	B-1
100-22-13-004	3/4 x 22	-	-	B-1

• Mini-vannes pour bande



Code du produit	Diamètre	Quantité/sachet		Type de carton
	mm	Sachet	Carton	
100-17-14-001	17 x 17	80	400	B-1
100-22-14-001	22 x 22	80	320	B-1

• Vannettes vissées mâles avec sortie de joint



Code du produit	Diamètre	Quantité/sachet		Type de carton
	mm	Sachet	Carton	
100-16-15-001	1/2 x 16	100	500	B-1
100-16-15-002	3/4 x 16	100	500	B-1

• Vannettes vissées mâles avec anneau



Code du produit	Diamètre	Quantité/sachet		Type de carton
	mm	Sachet	Carton	
100-17-16-001	1/2 x 17	90	450	B-1
100-17-16-002	3/4 x 17	90	450	B-1
100-22-16-003	1/2 x 22	90	360	B-1
100-22-16-004	3/4 x 22	90	360	B-1
100-25-16-005	1/2 x 25	-	-	B-1
100-25-16-006	3/4 x 25	-	-	B-1
100-28-16-007	1/2 x 28	-	-	B-1
100-28-16-008	3/4 x 28	-	-	B-1

• Vannettes vissées mâles



Code du produit	Diamètre	Quantité/sachet		Type de carton
	mm	Sachet	Carton	
100-16-17-001	1/2 x 1/2	80	400	B-1
100-16-17-002	3/4 x 3/4	80	400	B-1

• Vannettes avec sortie de joint et anneau



Code du produit	Diamètre	Quantité/sachet		Type de carton
	mm	Sachet	Carton	
100-16-18-001	16 x 17	100	500	B-1
100-16-18-002	16 x 22	100	500	B-1
100-20-18-003	20 x 22	100	400	B-1
100-20-18-004	20 x 25	-	-	B-1
100-25-18-005	25 x 25	-	-	B-1
100-25-18-006	25 x 28	-	-	B-1

• Vannettes à queue d'aronde avec anneau



Code du produit	Diamètre	Quantité/sachet		Type de carton
	mm	Sachet	Carton	
100-16-19-001	16 x 17	100	500	B-1
100-16-19-002	16 x 22	100	400	B-1
100-20-19-003	20 x 22	100	400	B-1

Irrigation Goutte à Goutte

Tubes Ronds d'irrigation Goutte à Goutte

• Vannettes à gaine avec anneau



Code du produit	Diamètre	Quantité/sachet		Type de carton
		Sachet	Carton	
	mm			
100-17-20-001	17 x 17	90	450	B-1
100-17-20-002	17 x 22	90	360	B-1
100-22-20-003	22 x 22	90	360	B-1

• Vannettes Avec Anneau



Code du produit	Diamètre	Quantité/sachet		Type de carton
		Sachet	Carton	
	mm			
100-17-21-001	17 x 17	100	500	B-1
100-22-21-002	22 x 22	100	400	B-1
100-25-21-003	25 x 25	-	-	B-1
100-28-21-004	28 x 28	-	-	B-1

• Vannettes à queue d'aronde avec sortie lay-flat



Code du produit	Diamètre	Quantité/sachet		Type de carton
		Sachet	Carton	
	pouces x mm			
100-16-22-001	1/2 x 16	80	400	B-1
100-20-22-002	1/2 x 20	80	320	-

• Vannettes à gaine avec sortie lay-flat



Code du produit	Diamètre	Quantité/sachet		Type de carton
		Sachet	Carton	
	mm			
100-17-23-001	1/2 x 17	70	150	B-1
100-22-23-001	1/2 x 22	-	-	B-1

• Vannettes de sortie lay-flat avec anneau



Code du produit	Diamètre	Quantité/sachet		Type de carton
		Sachet	Carton	
	pouces x mm			
100-17-24-001	1/2 x 17	80	400	B-1
100-22-24-001	1/2 x 22	80	320	B-1
100-25-24-001	1/2 x 25	-	-	B-1
100-28-24-001	1/2 x 28	-	-	B-1

• Vannettes mâles vissées avec sortie lay-flat



Code du produit	Diamètre	Quantité/sachet		Type de carton
		Sachet	Carton	
	mm			
100-16-25-001	1/2 x 1/2	70	350	B-1

• Raccord d'irrigation goutte à goutte



Code du produit	Diamètre	Quantité/ sachet		Type de carton
	mm	Sachet	Carton	
150-16-01-001	16 x 16	550	2200	B-1
150-20-01-002	20 x 20	400	1600	B-1

• Raccord de sortie d'irrigation goutte à goutte



Code du produit	Diamètre	Quantité/ sachet		Type de carton
	mm	Sachet	Carton	
200-16-01-001	16 x 16	550	2200	B-1
200-20-01-002	20 x 20	400	1600	B-1

• Té cannelé / Dérivation à joint en Té



Code du produit	Diamètre	Quantité/ sachet		Type de carton
	mm	Sachet	Carton	
250-16-03-001	16 x 16 x 16	350	1400	B-1
250-20-03-002	20 x 16 x 20	225	900	B-1
250-20-03-003	20 x 20 x 20	200	800	B-1

• Coude d'irrigation goutte à goutte



Code du produit	Diamètre	Quantité/ sachet		Type de carton
	mm	Sachet	Carton	
300-16-04-001	16 x 16	550	2200	B-1
300-20-04-002	20 x 20	350	1400	B-1

• Réduction d'irrigation goutte à goutte



Code du produit	Diamètre	Quantité/ sachet		Type de carton
	mm	Sachet	Carton	
500-20-08-001	20x 16	500	2000	B-1

• Bande de Raccordement Goutte à Goutte



Code du produit	Diamètre	Quantité/ sachet		Type de carton
	mm	Sachet	Carton	
150-17-03-001	17 x 17	200	800	B-1

• Bande de Raccordement Goutte à Goutte



Code du produit	Diamètre	Quantité/ sachet		Type de carton
	mm	Sachet	Carton	
200-17-01-001	16 x 17	300	1200	B-1

• Bande sortie en queue d'aronde d'Irrigation goutte à goutte



Code du produit	Diamètre	Quantité/ sachet		Type de carton
	mm	Sachet	Carton	
250-17-02-001	16 x 17	300	1200	B-1

Irrigation Goutte à Goutte

Tubes Ronds d'irrigation Goutte à Goutte

• Bouchons d'Irrigation Goutte à Goutte



Code du produit	Diamètre	Quantité/sachet		Type de carton
	mm	Sachet	Carton	
400-16-06-001	16-Spectacle	750	3000	B-1
400-20-06-002	20-Spectacle	400	1600	B-1
350-16-05-001	16-Stopper	800	3200	B-1
210-16-01-001	16-Hole Plug	1100	4400	B-1

• Joint d'étanchéité



Code du produit	Diamètre	Quantité/sachet		Type de carton
	mm	Sachet	Carton	
450-16-20-001	16-Conical	1.100	4400	B-1
450-16-20-002	16-Grooved	1.100	4400	B-1
450-20-20-004	20-Grooved	1.000	4000	B-1
450-25-20-004	25-Grooved	-	-	B-1

• Outil de perforation de tuyau principal (manuel)



Code du produit	Diamètre	Quantité/sachet		Type de carton
	mm	Sachet	Carton	
950-14-01-001	14	50	300	B-1
950-16-01-001	16	50	300	B-1
950-20-01-001	20	50	300	B-1
950-25-01-001	25	50	300	B-1

• Outil de perforation de tuyau principal (pour foret)



Code du produit	Diamètre	Quantité/sachet		Type de carton
	mm	Sachet	Carton	
950-14-01-002	14	100	-	-
950-16-01-002	16	100	-	-
950-20-01-002	20	100	-	-
950-25-01-002	25	100	-	-

• Outil de perforation pour goutteur



Code du produit	Diamètre	Quantité/sachet		Type de carton
	mm	Sachet	Carton	
900-30-01-002	3,0	50	500	B-1

• Goutteur



Code du produit	Diamètre	Quantité/sachet		Type de carton
	Lt/h	Sachet	Carton	
160-30-01-070	0-70	2.000	8000	B-1
160-30-01-140	0-140	900	3600	B-1

• Connecteur mamelon avec anneau



Code du produit	Diamètre	Quantité/sachet		Type de carton
		Sachet	Carton	
	mm			
150-017-17-001	17 x 17	400	1600	B-1
150-022-22-001	22 x 22	200	800	B-1
150-025-25-001	25 x 25	-	-	B-1
150-028-28-001	28 x 28	-	-	B-1

• Bouchon avec anneau



Product Code	Product Diameter	Packing Quantity		Type de carton
		Sachet	Carton	
	mm			
350-17-05-001	17	500	2000	B-1
350-22-05-001	22	250	1000	B-1

• Connecteur queue d'aronde noeud avec anneau



Code du produit	Diamètre	Quantité/sachet		Type de carton
		Sachet	Carton	
	mm			
250-17-16-001	17 x 16	500	2000	B-1
250-22-20-001	22 x 20	200	800	B-1

• Bague de raccordement avec anneau



Code du produit	Diamètre	Quantité/sachet		Type de carton
		Sachet	Carton	
	mm			
200-17-16-001	17 x 16	500	2000	B-1
200-22-20-001	22 x 20	200	800	B-1
200-20-25-001	20 x 25	-	-	B-1
200-25-25-001	25 x 25	-	-	B-1
200-25-28-001	25 x 28	-	-	B-1

• Filtres à disque double corps en plastique

Connection Diameter	Code du produit	Type de connection	Type	Capacité	Surface de filtration	Type de carton
				m ³ /h	cm ²	
3"	960-030-01-01	BSPT x BSPT	Court	70	2670	B-4
	960-030-01-02	V x V				
	960-030-02-01	BSPT x BSPT	Long	100	3615	B-5
	960-030-02-02	V x V				
4"	960-040-01-01	BSPT x BSPT	Court	70	2670	B-4
	960-040-01-02	V x V				
	960-040-02-01	BSPT x BSPT	Long	100	3615	B-5
	960-040-02-02	V x V				

• Filtre Double à Tamis en plastique

Connection Diameter	Code du produit	Type de connection	Type	Capacité	Surface de filtration	Type de carton
				m ³ /h	cm ²	
3"	960-030-01-03	BSPT x BSPT	Court	70	2435	B-4
	960-030-01-04	V x V				
	960-030-02-03	BSPT x BSPT	Long	100	3245	B-5
	960-030-02-04	V x V				
4"	960-040-01-03	BSPT x BSPT	Court	70	2435	B-4
	960-040-01-04	V x V				
	960-040-02-03	BSPT x BSPT	Long	100	3245	B-5
	960-040-02-04	V x V				

• Filtres à disque unique en plastique

Connection Diameter	Code du produit	Type de connection	Type	Capacité	Surface de filtration	Type de carton
				m ³ /h	cm ²	
2"	910-020-01-01	BSPT x BSPT x BSPT	Court	40	1335	B-3
	910-020-01-02	V x V x BSPT				
	910-020-01-03	V x BSPT x V				
	910-020-02-01	BSPT x BSPT x BSPT	Long	40	1810	B-3
	910-020-02-02	V x V x BSPT				
	910-020-02-03	V x BSPT x V				
2 ½"	910-025-01-01	BSPT x BSPT x BSPT	Court	48	1335	B-3
	910-025-01-02	V x V x BSPT				
	910-025-01-03	V x BSPT x V				
	910-025-02-01	BSPT x BSPT x BSPT	Long	48	1810	B-3
	910-025-02-02	V x V x BSPT				
	910-025-02-03	V x BSPT x V				
3"	910-030-01-01	BSPT x BSPT x BSPT	Court	55	1335	B-3
	910-030-01-02	V x V x BSPT				
	910-030-01-03	V x BSPT x V				
	910-030-02-01	BSPT x BSPT x BSPT	Long	55	1810	B-3
	910-030-02-02	V x V x BSPT				
	910-030-02-03	V x BSPT x V				

• Filtres à Tamis en plastique

Connection Diameter	Code du produit	Type de connection	Type	Capacité	Surface de filtration	Type de carton
				m ³ /h	cm ²	
2"	910-020-01-04	BSPT x BSPT x BSPT	Court	40	1210	B-3
	910-020-01-05	V x V x BSPT				
	910-020-01-06	V x BSPT x V				
	910-020-02-04	BSPT x BSPT x BSPT	Long	40	1620	B-3
	910-020-02-05	V x V x BSPT				
	910-020-02-06	V x BSPT x V				
2 1/2"	910-025-01-04	BSPT x BSPT x BSPT	Court	48	1210	B-3
	910-025-01-05	V x V x BSPT				
	910-025-01-06	V x BSPT x V				
	910-025-02-04	BSPT x BSPT x BSPT	Long	48	1620	B-3
	910-025-02-05	V x V x BSPT				
	910-025-02-06	V x BSPT x V				
3"	910-030-01-04	BSPT x BSPT x BSPT	Court	55	1210	B-3
	910-030-01-05	V x V x BSPT				
	910-030-01-06	V x BSPT x V				
	910-030-02-04	BSPT x BSPT x BSPT	Long	55	1620	B-3
	910-030-02-05	V x V x BSPT				
	910-030-02-06	V x BSPT x V				

• Filtres à disque double corps en plastique

Série en métal clampé

Connection Diameter	Code du produit	Type de connection	Type	Capacité	Surface de filtration	Type de carton
				m ³ /h	cm ²	
3"	950-030-01-01	BSPT x BSPT	Court	70	2670	B-4
	950-030-01-02	V x V				
	950-030-02-01	BSPT x BSPT	Long	100	3615	B-5
	950-030-02-02	V x V				
4"	950-040-01-01	BSPT x BSPT	Court	70	2670	B-4
	950-040-01-02	V x V				
	950-040-02-01	BSPT x BSPT	Long	100	3615	B-5
	950-040-02-02	V x V				

• Filtre Double à Tamis en plastique

Connection Diameter	Code du produit	Type de connection	Type	Capacité	Surface de filtration	Type de carton
				m ³ /h	cm ²	
3"	950-030-01-03	BSPT x BSPT	Court	70	2435	B-4
	950-030-01-04	V x V				
	950-030-02-03	BSPT x BSPT	Long	100	3245	B-5
	950-030-02-04	V x V				
4"	950-040-01-03	BSPT x BSPT	Court	70	2435	B-4
	950-040-01-04	V x V				
	950-040-02-03	BSPT x BSPT	Long	100	3245	B-5
	950-040-02-04	V x V				

▲ Systèmes de filtrage

Filtre En Plastique

- Filtres à disque unique en plastique

Connection Diameter	Code du produit	Type de connection	Type	Capacité	Surface de filtration	Type de carton
pouces				m ³ /h	cm ²	
2"	900-020-01-01	BSPT x BSPT x BSPT	Court	40	1335	B-3
	900-020-01-02	V x V x BSPT				
	900-020-01-03	V x BSPT x V				
	900-020-02-01	BSPT x BSPT x BSPT	Long	40	1810	B-3
	900-020-02-02	V x V x BSPT				
	900-020-02-03	V x BSPT x V				
2 ½"	900-025-01-01	BSPT x BSPT x BSPT	Court	48	1335	B-3
	900-025-01-02	V x V x BSPT				
	900-025-01-03	V x BSPT x V				
	900-025-02-01	BSPT x BSPT x BSPT	Long	48	1810	B-3
	900-025-02-02	V x V x BSPT				
	900-025-02-03	V x BSPT x V				
3"	900-030-01-01	BSPT x BSPT x BSPT	Court	55	1335	B-3
	900-030-01-02	V x V x BSPT				
	900-030-01-03	V x BSPT x V				
	900-030-02-01	BSPT x BSPT x BSPT	Long	55	1810	B-3
	900-030-02-02	V x V x BSPT				
	900-030-02-03	V x BSPT x V				

- Filtres à Tamis en plastique

Connection Diameter	Product Code	Connection Type	Type	Capacity	Surface de filtration	Type de carton
pouces				m ³ /h	cm ²	
2"	900-020-01-04	BSPT x BSPT x BSPT	Court	40	1210	B-3
	900-020-01-05	V x V x BSPT				
	900-020-01-06	V x BSPT x V				
	900-020-02-04	BSPT x BSPT x BSPT	Long	40	1620	B-3
	900-020-02-05	V x V x BSPT				
	900-020-02-06	V x BSPT x V				
2 ½"	900-025-01-04	BSPT x BSPT x BSPT	Court	48	1210	B-3
	900-025-01-05	V x V x BSPT				
	900-025-01-06	V x BSPT x V				
	900-025-02-04	BSPT x BSPT x BSPT	Long	48	1620	B-3
	900-025-02-05	V x V x BSPT				
	900-025-02-06	V x BSPT x V				
3"	900-030-01-04	BSPT x BSPT x BSPT	Court	55	1210	B-3
	900-030-01-05	V x V x BSPT				
	900-030-01-06	V x BSPT x V				
	900-030-02-04	BSPT x BSPT x BSPT	Long	55	1620	B-3
	900-030-02-05	V x V x BSPT				
	900-030-02-06	V x BSPT x V				

• Filtres à disque Type Y **+** plus

	Code du produit	Diamètre de la Connection	Tipo de Connection	Capacité	Surface de filtration	Quantité par paquet		Type de carton
		pouces		m ³ /h	cm ²	Sachet	Carton	
	800-112-01-01	1 ½"	BSPT x BSPT	20	559,20	1	15	B-2
	800-200-01-01	2"	BSPT x BSPT	25	559,20	1	15	B-2

• Filtres à disque Type Y **+** midi

	Code du produit	Diamètre de la Connection	Tipo de Connection	Capacité	Surface de filtration	Quantité par paquet		Type de carton
		pouces		m ³ /h	cm ²	Sachet	Carton	
	800-114-02-01	1 ¼"	BSPT x BSPT	10	311,96	1	32	B-2
	800-112-02-01	1 ½"	BSPT x BSPT	15	311,96	1	32	B-2

• Filtres à disque Type Y **+** mini

	Code du produit	Diamètre de la Connection	Tipo de Connection	Capacité	Surface de filtration	Quantité par paquet		Type de carton
		pouces		m ³ /h	cm ²	Sachet	Carton	
	800-034-03-01	¾"	BSPT x BSPT	6	172,25	1	60	B-2
	800-100-03-01	1"	BSPT x BSPT	17	172,25	1	60	B-2

• Filtres à disque Type Y **+** plus

	Code du produit	Diamètre de la Connection	Tipo de Connection	Capacité	Surface de filtration	Quantité par paquet		Type de carton
		pouces		m ³ /h	cm ²	Sachet	Carton	
	800-112-01-02	1 ½"	BSPT x BSPT	20	525,43	1	15	B-2
	800-200-01-02	2"	BSPT x BSPT	25	525,43	1	15	B-2

• Filtres à disque Type Y **+** midi

	Code du produit	Diamètre de la Connection	Tipo de Connection	Capacité	Surface de filtration	Quantité par paquet		Type de carton
		pouces		m ³ /h	cm ²	Sachet	Carton	
	800-114-02-02	1 ¼"	BSPT x BSPT	10	322,54	1	32	B-2
	800-112-02-02	1 ½"	BSPT x BSPT	15	322,54	1	32	B-2

• Filtres à disque Type Y **+** mini

	Code du produit	Diamètre de la Connection	Tipo de Connection	Capacité	Surface de filtration	Quantité par paquet		Type de carton
		pouces		m ³ /h	cm ²	Sachet	Carton	
	800-034-03-02	¾"	BSPT x BSPT	6	178,47	1	60	B-2
	800-100-03-02	1"	BSPT x BSPT	17	178,47	1	60	B-2

• Cartouche pour filtre à Disques en plastique



Code du produit	Dimensions du produit	Quantité	Type de carton
	Type	Carton	
999-234-00-01	2"-2½"-3"-4" Court	12	B-2
999-234-00-02	2"-2½"-3"-4" Long	8	B-2

• Cartouche pour filtre à Tamis en plastique



Code du produit	Dimensions du produit	Quantité	Type de carton
	cm	Carton	
997-020-00-01	12,5	60	B-2
997-025-00-01	25	28	B-2
997-030-00-01	37,5	16	B-2
997-040-00-01	50	12	B-2

• Cartouche pour filtre à Disques en metal



Code du produit	Dimensions du produit	Quantité	Type de carton
	cm	Carton	
998-020-25-01	25	18	B-2
998-025-35-01	35	12	B-2
998-030-40-01	40	12	B-2
998-040-50-01	50	8	B-2
998-050-60-01	60	8	B-2

• Cartouche pour filtre à disque



Code du produit	Dimensions du produit	Quantité	Type de carton
	cm	Carton	
899-100-01-01	+plus	28	B-1
899-200-02-01	midi	54	B-1
899-300-03-01	mini	112	B-1

• Cartouche pour Filtre à Tamis Type Y



Code du produit	Dimensions du produit	Quantité	Type de carton
	cm	Carton	
897-100-01-02	+plus	28	B-1
897-200-02-02	midi	54	B-1
897-300-03-02	mini	112	B-1

• Raccord Manchon Mâle

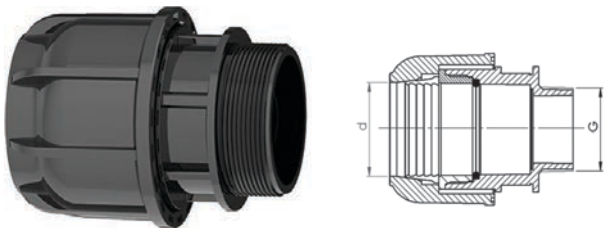

Code du produit	Diamètre	Quantité		
		Sachet	Carton	Sac
	d x d			
110-020-10001	20 x 1/2"	100	100	1000
110-020-10002	20 x 3/4"	100	100	1000
110-025-10005	25 x 1/2"	50	50	500
110-025-10006	25 x 3/4"	50	50	500
110-025-10007	25 x 1"	50	50	500
110-032-10012	32 x 3/4"	50	50	400
110-032-10013	32 x 1"	50	50	400
110-032-10014	32 x 1 1/4"	50	50	400
110-040-10021	40 x 1"	30	30	240
110-040-10022	40 x 1 1/4"	30	30	240
110-040-10023	40 x 1 1/2"	30	30	240
110-050-10032	50 x 1 1/4"	20	20	140
110-050-10033	50 x 1 1/2"	20	20	140
110-050-10035	50 x 2"	20	20	140
110-063-10044	63 x 1 1/4"	12	72	96
110-063-10045	63 x 1 1/2"	12	72	96
110-063-10047	63 x 2"	12	72	96
110-063-10049	63 x 2 1/2"	12	72	96
110-075-10059	75 x 2"	6	36	54
110-075-10061	75 x 2 1/2"	6	36	54
110-075-10063	75 x 3"	6	36	54
110-090-10075	90 x 2"	6	24	36
110-090-10077	90 x 2 1/2"	6	24	36
110-090-10079	90 x 3"	6	24	36
110-090-10083	90 x 4"	6	24	36
110-110-10091	110 x 2"	4	12	20
110-110-10093	110 x 2 1/2"	4	12	20
110-110-10095	110 x 3"	4	12	20
110-110-10099	110 x 4"	4	12	20
Type de carton		B-2		
Type de sac		S-1		

• Raccord Manchon Femelle

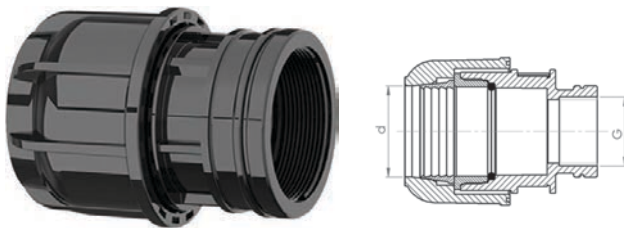

Code du produit	Diamètre	Quantité		
		Sachet	Carton	Sac
	d x d			
110-020-11001	20 x 1/2"	100	800	1000
110-020-11002	20 x 3/4"	100	800	1000
110-025-11005	25 x 1/2"	50	400	500
110-025-11006	25 x 3/4"	50	400	500
110-025-11007	25 x 1"	50	400	500
110-032-11012	32 x 3/4"	50	250	350
110-032-11013	32 x 1"	50	250	350
110-032-11014	32 x 1 1/4"	50	250	350
110-040-11021	40 x 1"	20	140	200
110-040-11022	40 x 1 1/4"	20	140	200
110-040-11023	40 x 1 1/2"	20	140	200
110-050-11032	50 x 1 1/4"	15	90	120
110-050-11033	50 x 1 1/2"	15	90	120
110-050-11035	50 x 2"	15	90	120
110-063-11045	63 x 1 1/2"	12	72	96
110-063-11047	63 x 2"	12	72	96
110-063-11049	63 x 2 1/2"	12	72	96
110-075-11059	75 x 2"	6	36	54
110-075-11061	75 x 2 1/2"	6	36	54
110-075-11063	75 x 3"	6	36	54
110-090-11075	90 x 2"	6	24	30
110-090-11077	90 x 2 1/2"	6	24	30
110-090-11079	90 x 3"	6	24	30
110-090-11083	90 x 4"	6	24	30
110-110-11091	110 x 2"	4	12	20
110-110-11093	110 x 2 1/2"	4	12	20
110-110-11095	110 x 3"	4	12	20
110-110-11099	110 x 4"	4	12	20
Type de carton		B-2		
Type de sac		S-1		

Raccords de compression

Black Series-PN 10

• Raccord Manchon Té Mâle



Code du produit	Diamètre	Quantité		
		Sachet	Carton	Sac
	d x d			
110-020-15001	20 x ½" x 20	30	300	360
110-020-15002	20 x ¾" x 20	30	300	360
110-025-15005	25 x ½" x 25	20	160	200
110-025-15006	25 x ¾" x 25	20	160	200
110-025-15007	25 x 1" x 25	20	160	200
110-025-15008	25 x 1¼" x 25	20	160	200
110-032-15012	32 x ¾" x 32	20	120	140
110-032-15013	32 x 1" x 32	20	120	140
110-032-15014	32 x 1¼" x 32	20	120	140
110-040-15021	40 x 1" x 40	10	60	80
110-040-15022	40 x 1¼" x 40	10	60	80
110-040-15023	40 x 1½" x 40	10	60	80
110-050-15031	50 x 1" x 50	4	40	52
110-050-15032	50 x 1¼" x 50	4	40	52
110-050-15033	50 x 1½" x 50	4	40	52
110-050-15035	50 x 2" x 50	4	40	50
110-063-15044	63 x 1¼" x 63	4	24	32
110-063-15045	63 x 1½" x 63	4	24	32
110-063-15047	63 x 2" x 63	4	24	32
110-063-15049	63 x 2½" x 63	4	24	32
110-075-15059	75 x 2" x 75	2	12	18
110-075-15061	75 x 2½" x 75	2	12	18
110-075-15063	75 x 3" x 75	2	12	18
110-090-15077	90 x 2½" x 90	2	8	12
110-090-15079	90 x 3" x 90	2	8	12
110-090-15083	90 x 4" x 90	2	8	12
110-110-15093	110x2½"x110	2	4	8
110-110-15095	110 x 3" x 110	2	4	8
110-110-15099	110 x 4" x 110	2	4	8
Type de carton		B-2		
Type de sac		S-1		

• Raccord Manchon Té Femelle

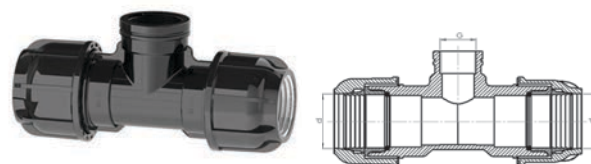

Code du produit	Diamètre	Quantité		
		Sachet	Carton	Sac
	d x d			
110-020-16001	20 x ½" x 20	30	300	360
110-020-16002	20 x ¾" x 20	30	300	360
110-025-16005	25 x ½" x 25	20	160	200
110-025-16006	25 x ¾" x 25	20	160	200
110-025-16007	25 x 1" x 25	20	160	200
110-032-16011	32 x ½" x 32	20	100	140
110-032-16012	32 x ¾" x 32	20	100	140
110-032-16013	32 x 1" x 32	20	100	140
110-032-16014	32 x 1¼" x 32	20	100	140
110-040-16020	40 x ¾" x 40	10	60	80
110-040-16021	40 x 1" x 40	10	60	80
110-040-16022	40 x 1¼" x 40	10	60	80
110-040-16023	40 x 1½" x 40	10	60	80
110-050-16030	50 x ¾" x 50	4	36	48
110-050-16031	50 x 1" x 50	4	36	48
110-050-16032	50 x 1¼" x 50	4	36	48
110-050-16033	50 x 1½" x 50	4	4	48
110-050-16035	50 x 2" x 50	4	4	48
110-063-16043	63 x 1" x 63	4	4	32
110-063-16044	63 x 1¼" x 63	4	4	32
110-063-16045	63 x 1½" x 63	4	4	32
110-063-16047	63 x 2" x 63	4	4	32
110-063-16049	63 x 2½" x 63	4	4	32
110-075-16059	75 x 2" x 75	2	2	18
110-075-16061	75 x 2½" x 75	2	2	18
110-075-16063	75 x 3" x 75	2	2	18
110-090-16077	90 x 2½" x 90	2	2	12
110-090-16079	90 x 3" x 90	2	2	12
110-090-16083	90 x 4" x 90	2	2	12
110-110-16093	110x2½"x110	1	1	8
110-110-16095	110 x 3" x 110	1	1	8
110-110-16099	110 x 4" x 110	1	1	8
Type de carton		B-2		
Type de sac		S-1		

• Raccord Manchon Té



Code du produit	Diamètre d x d	Quantité		
		Sachet	Carton	Sac
110-020-13000	20 x 20 x 20	30	240	300
110-025-13004	25 x 25 x 25	20	120	180
110-032-13010	32 x 32 x 32	12	72	108
110-040-13018	40 x 40 x 40	10	60	80
110-050-13028	50 x 50 x 50	4	36	48
110-063-13040	63 x 63 x 63	4	24	32
110-075-13052	75 x 75 x 75	2	10	14
110-090-13068	90 x 90 x 90	2	6	8
110-110-13084	110 x 110 x 110	1	4	6
Type de carton		B-2		
Type de sac		S-1		

• Raccord Manchon Té de réduction

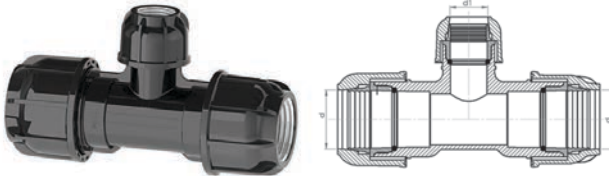

Code du produit	Diamètre d x d	Quantité		
		Sachet	Carton	Sac
110-020-14000	20 x 25 x 20	20	200	240
110-025-14004	25 x 20 x 25	20	160	200
110-025-14005	25 x 32 x 25	20	120	160
110-032-14010	32 x 20 x 32	10	90	120
110-032-14011	32 x 25 x 32	10	80	120
110-040-14019	40 x 25 x 40	10	80	90
110-040-14020	40 x 32 x 40	10	60	90
110-050-14029	50 x 25 x 50	4	40	48
110-050-14030	50 x 32 x 50	4	40	48
110-050-14031	50 x 40 x 50	4	40	48
110-063-14041	63 x 25 x 63	4	24	32
110-063-14042	63 x 32 x 63	4	24	32
110-063-14043	63 x 40 x 63	4	24	32
110-063-14044	63 x 50 x 63	4	24	32
110-075-14056	75 x 50 x 75	2	10	16
110-075-14057	75 x 63 x 75	2	10	16
110-090-14073	90 x 63 x 90	2	8	10
110-090-14074	90 x 75 x 90	2	8	10
110-110-14089	110 x 63 x 110	1	4	6
110-110-14091	110 x 90 x 110	1	4	6
Type de carton		B-2		
Type de sac		S-1		

• Manchon d'accouplement



Code du produit	Diamètre d x d	Quantité		
		Sachet	Carton	Sac
110-020-22000	20 x 20	50	450	600
110-025-22004	25 x 25	50	300	350
110-032-22010	32 x 32	30	180	240
110-040-22018	40 x 40	20	80	140
110-050-22028	50 x 50	10	70	90
110-063-22040	63 x 63	8	48	56
110-075-22052	75 x 75	4	20	28
110-090-22068	90 x 90	4	16	20
110-110-22084	110 x 110	2	6	10
Type de carton		B-2		
Type de sac		S-1		

Raccords de compression

• Raccord Coude mâle

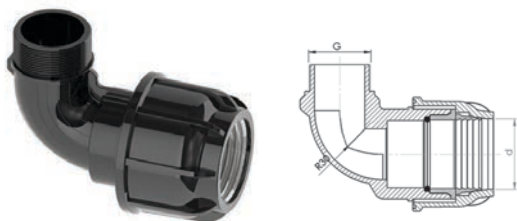

Code du produit	Diamètre d x d	Quantité		
		Sachet	Carton	Sac
110-020-19001	20 x ½"	50	600	700
110-020-19002	20 x ¾"	50	600	700
110-025-19005	25 x ½"	30	360	420
110-025-19006	25 x ¾"	30	360	420
110-025-19007	25 x 1"	30	360	420
110-032-19012	32 x ¾"	20	180	240
110-032-19013	32 x 1"	20	180	240
110-032-19014	32 x 1¼"	20	180	240
110-040-19021	40 x 1"	10	120	140
110-040-19022	40 x 1¼"	10	120	140
110-040-19023	40 x 1½"	10	120	140
110-050-19032	50 x 1¼"	10	70	100
110-050-19033	50 x 1½"	10	70	100
110-050-19035	50 x 2"	10	70	100
110-063-19045	63 x 1½"	8	48	64
110-063-19047	63 x 2"	8	48	64
110-063-19049	63 x 2½"	8	48	64
110-075-19059	75 x 2"	4	24	32
110-075-19061	75 x 2½"	4	24	32
110-075-19063	75 x 3"	4	24	32
110-090-19077	90 x 2½"	2	14	18
110-090-19079	90 x 3"	2	14	18
110-090-19083	90 x 4"	2	14	18
110-110-19095	110 x 3"	2	8	14
110-110-19099	110 x 4"	2	8	14
Type de carton		B-2		
Type de sac		S-1		

• Raccord Coude Femelle

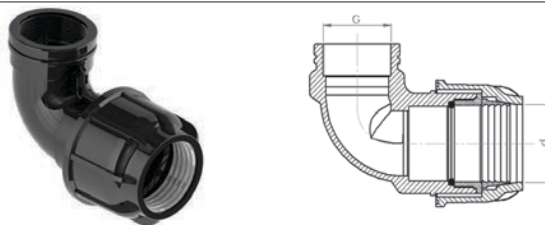

Code du produit	Diamètre d x d	Quantité		
		Sachet	Carton	Sac
110-020-20001	20 x ½"	50	600	700
110-020-20002	20 x ¾"	50	500	700
110-025-20005	25 x ½"	30	300	420
110-025-20006	25 x ¾"	30	300	420
110-025-20007	25 x 1"	30	300	420
110-032-20012	32 x ¾"	20	180	240
110-032-20013	32 x 1"	20	180	240
110-032-20014	32 x 1¼"	20	180	240
110-040-20021	40 x 1"	10	120	140
110-040-20022	40 x 1¼"	10	120	140
110-040-20023	40 x 1½"	10	120	140
110-050-20032	50 x 1¼"	10	70	100
110-050-20033	50 x 1½"	10	70	100
110-050-20035	50 x 2"	10	70	100
110-063-20045	63 x 1½"	8	48	64
110-063-20047	63 x 2"	8	48	64
110-063-20049	63 x 2½"	8	48	64
110-075-20059	75 x 2"	4	24	32
110-075-20061	75 x 2½"	4	24	32
110-075-20063	75 x 3"	4	24	32
110-090-20077	90 x 2½"	2	14	18
110-090-20079	90 x 3"	2	14	18
110-090-20083	90 x 4"	2	14	18
110-110-20095	110 x 3"	2	8	14
110-110-20099	110 x 4"	2	8	14
Type de carton		B-2		
Type de sac		S-1		

• Raccord Coude

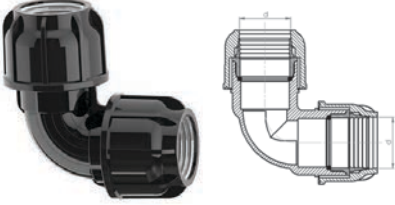
	<table border="1"> <tr> <td>Type de carton</td> <td>B-2</td> </tr> <tr> <td>Type de sac</td> <td>S-1</td> </tr> </table>	Type de carton	B-2	Type de sac	S-1	Code du produit	Diamètre	Quantité		
		Type de carton	B-2							
Type de sac	S-1									
			d x G	Sachet	Carton	Sac				
		110-020-18000	20 x 20	50	400	600				
		110-025-18004	25 x 25	30	210	270				
		110-032-18010	32 x 32	20	140	180				
		110-040-18018	40 x 40	12	72	108				
		110-050-18028	50 x 50	8	48	64				
		110-063-18040	63 x 63	8	32	48				
		110-075-18052	75 x 75	4	16	24				
		110-090-18068	90 x 90	2	10	16				
		110-110-18084	110 x 110	1	6	10				

• Raccord de Réduction – Coude

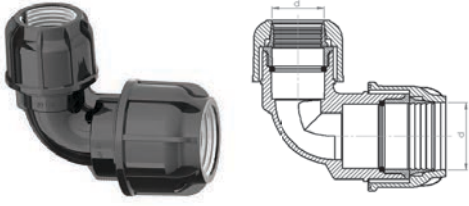
	<table border="1"> <tr> <td>Type de carton</td> <td>B-2</td> </tr> <tr> <td>Type de sac</td> <td>S-1</td> </tr> </table>	Type de carton	B-2	Type de sac	S-1	Code du produit	Diamètre	Quantité		
		Type de carton	B-2							
Type de sac	S-1									
			d x d	Sachet	Carton	Sac				
		110-025-21004	25 x 20	30	300	360				
		110-032-21011	32 x 25	20	160	200				
		110-040-21020	40 x 32	10	90	120				
		110-050-21031	50 x 40	8	64	80				
		110-063-21044	63 x 50	8	40	56				
		110-075-21057	75 x 63	4	24	32				
		110-090-21074	90 x 75	2	10	16				
		110-110-21091	110 x 90	2	8	12				

• Manchon de Réduction – Coude

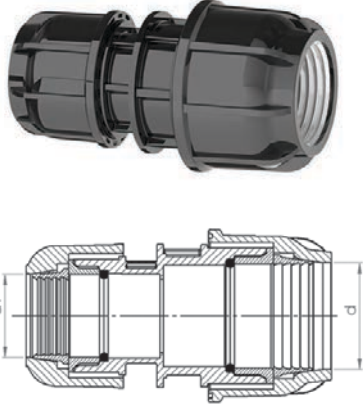
	<table border="1"> <tr> <td>Type de carton</td> <td>B-2</td> </tr> <tr> <td>Type de sac</td> <td>S-1</td> </tr> </table>	Type de carton	B-2	Type de sac	S-1	Code du produit	Diamètre	Quantité		
		Type de carton	B-2							
Type de sac	S-1									
			d x d	Sachet	Carton	Sac				
		110-025-23004	25 x 20	50	300	400				
		110-032-23010	32 x 20	20	200	240				
		110-032-23011	32 x 25	20	200	240				
		110-040-23018	40 x 20	20	120	180				
		110-040-23019	40 x 25	20	120	180				
		110-040-23020	40 x 32	20	120	180				
		110-050-23029	50 x 25	10	80	90				
		110-050-23030	50 x 32	10	80	90				
		110-050-23031	50 x 40	10	80	90				
		110-063-23041	63 x 25	10	60	70				
		110-063-23042	63 x 32	10	60	70				
		110-063-23043	63 x 40	10	60	70				
		110-063-23044	63 x 50	10	50	70				
		110-075-23056	75 x 50	3	27	36				
		110-075-23057	75 x 63	3	27	36				
		110-090-23073	90 x 63	3	18	24				
		110-090-23074	90 x 75	3	18	24				
		110-110-23089	110 x 63	2	8	14				
		110-110-23090	110 x 75	2	8	14				
		110-110-23091	110 x 90	2	8	14				

Raccords de compression

Black Series-PN 10

• Adaptateur de couplage à épaule

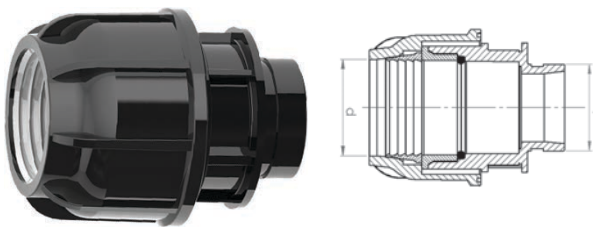

Code du produit	Diamètre	Quantité		
		Sachet	Carton	Sac
	d x d			
110-063-12047	63 x 2"	12	72	96
110-110-12099	110 x 4"	4	12	20
Type de carton		B-2		
Type de sac		S-1		

• Adaptateur d'épaule de couplage TE

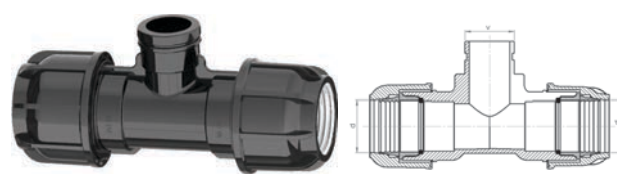

Code du produit	Diamètre	Quantité		
		Sachet	Carton	Sac
	d x d			
110-063-17047	63 x 2" x 63	4	24	32
110-110-17091	110 x 4" x 110	1	4	8
Type de carton		B-2		
Type de sac		S-1		

• Embout/Bouchon d'accouplement



Code du produit	Diamètre	Quantité		
		Sachet	Carton	Sac
	d x d			
110-020-24000	20	100	1.000	1100
110-025-24004	25	50	500	600
110-032-24010	32	50	300	400
110-040-24018	40	30	150	270
110-050-24028	50	16	112	144
110-063-24040	63	12	72	96
110-075-24052	75	6	36	54
110-090-24068	90	6	24	36
110-110-24084	110	4	12	20
Type de carton		B-2		
Type de sac		S-1		

• Clé de Couplage



Code du produit	Diamètre	Quantité	
		Sachet	Carton
	d x d		
010-000-25000	20 - 25 - 32	5	150
010-000-25001	40 - 50 - 63 - 75	5	75
010-000-25002	90 - 110	5	40
Type de carton		B-2	
Type de sac		S-1	

• Colliers de prise avec sortie unique

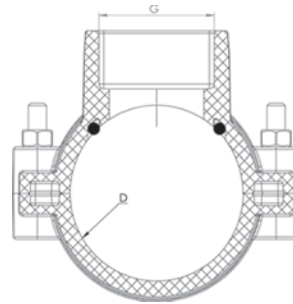

Type de carton

B-2

Type de sac

S-1

Code du produit	Diamètre	Quantité	
	d x G	Carton	Sac
010-025-50005	25 x ½"	400	600
010-032-50011	32 x ½"	350	500
010-032-50012	32 x ¾"	350	500
010-040-50019	40 x ½"	250	400
010-040-50020	40 x ¾"	250	400
010-050-50029	50 x ½"	180	200
010-050-50030	50 x ¾"	180	200
010-050-50031	50 x 1"	180	200
010-063-50041	63 x ½"	150	200
010-063-50042	63 x ¾"	150	200
010-063-50043	63 x 1"	150	200
010-063-50044	63 x 1 ¼"	150	200
010-063-50045	63 x 1 ½"	150	200
010-075-50053	75 x ½"	100	150
010-075-50054	75 x ¾"	100	150
010-075-50055	75 x 1"	100	150
010-075-50056	75 x 1 ¼"	100	150
010-075-50057	75 x 1 ½"	100	150
010-075-50059	75 x 2"	100	150
010-090-50069	90 x ½"	75	100
010-090-50070	90 x ¾"	75	100
010-090-50071	90 x 1"	75	100
010-090-50072	90 x 1 ¼"	75	100
010-090-50073	90 x 1 ½"	75	100
010-090-50075	90 x 2"	75	100

Code du produit	Diamètre	Quantité	
	d x G	Carton	Sac
010-110-50085	110 x ½"	60	100
010-110-50086	110 x ¾"	60	100
010-110-50087	110 x 1"	60	100
010-110-50088	110 x 1 ¼"	60	100
010-110-50089	110 x 1 ½"	60	100
010-110-50091	110 x 2"	60	100
010-125-50102	125 x ¾"	45	75
010-125-50103	125 x 1"	45	75
010-125-50104	125 x 1 ¼"	45	75
010-125-50105	125 x 1 ½"	45	75
010-125-50107	125 x 2"	45	75
010-140-50118	140 x ¾"	40	50
010-140-50119	140 x 1"	40	50
010-140-50120	140 x 1 ¼"	40	50
010-140-50121	140 x 1 ½"	40	50
010-140-50123	140 x 2"	40	50
010-160-50134	160 x ¾"	40	50
010-160-50135	160 x 1"	40	50
010-160-50136	160 x 1 ¼"	40	50
010-160-50137	160 x 1 ½"	40	50
010-160-50139	160 x 2"	40	50
010-200-50150	200 x ¾"	30	40
010-200-50151	200 x 1"	30	40
010-200-50152	200 x 1 ¼"	30	40
010-200-50153	200 x 1 ½"	30	40
010-200-50155	200 x 2"	30	40

• Colliers de prise avec double sortie

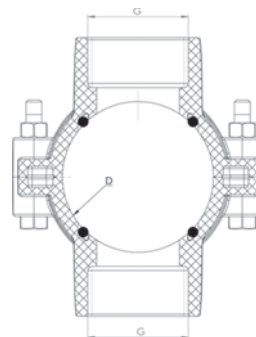

Type de carton	B-2
Type de sac	S-1

Code du produit	Dimensions	Quantité	
		Carton	Sac
	d x G x G		
010-025-55005	25 x 1/2" x 1/2"	400	600
010-032-55011	32 x 1/2" x 1/2"	350	500
010-032-55012	32 x 3/4" x 3/4"	350	500
010-040-55019	40 x 1/2" x 1/2"	250	400
010-040-55020	40 x 3/4" x 3/4"	250	400
010-050-55029	50 x 1/2" x 1/2"	180	200
010-050-55030	50 x 3/4" x 3/4"	180	200
010-050-55031	50 x 1" x 1"	180	200
010-063-55041	63 x 1/2" x 1/2"	150	200
010-063-55042	63 x 3/4" x 3/4"	150	200
010-063-55043	63 x 1" x 1"	150	200
010-063-55044	63 x 1 1/4" x 1 1/4"	150	200
010-063-55045	63 x 1 1/2" x 1 1/2"	150	200
010-075-55053	75 x 1/2" x 1/2"	100	150
010-075-55054	75 x 3/4" x 3/4"	100	150
010-075-55055	75 x 1" x 1"	100	150
010-075-55056	75 x 1 1/4" x 1 1/4"	100	150
010-075-55057	75 x 1 1/2" x 1 1/2"	100	150
010-075-55059	75 x 2" x 2"	100	150
010-090-55069	90 x 1/2" x 1/2"	75	100
010-090-55070	90 x 3/4" x 3/4"	75	100
010-090-55071	90 x 1" x 1"	75	100
010-090-55072	90 x 1 1/4" x 1 1/4"	75	100
010-090-55073	90 x 1 1/2" x 1 1/2"	75	100
010-090-55075	90 x 2" x 2"	75	100

Code du produit	Dimensions	Quantité	
		Carton	Sac
	d x G x G		
010-110-55085	110 x 1/2" x 1/2"	60	100
010-110-55086	110 x 3/4" x 3/4"	60	100
010-110-55087	110 x 1" x 1"	60	100
010-110-55088	110 x 1 1/4" x 1 1/4"	60	100
010-110-55089	110 x 1 1/2" x 1 1/2"	60	100
010-110-55091	110 x 2" x 2"	60	100
010-125-55102	125 x 3/4" x 3/4"	45	75
010-125-55103	125 x 1" x 1"	45	75
010-125-55104	125 x 1 1/4" x 1 1/4"	45	75
010-125-55105	125 x 1 1/2" x 1 1/2"	45	75
010-125-55107	125 x 2" x 2"	45	75
010-140-55118	140 x 3/4" x 3/4"	40	50
010-140-55119	140 x 1" x 1"	40	50
010-140-55120	140 x 1 1/4" x 1 1/4"	40	50
010-140-55121	140 x 1 1/2" x 1 1/2"	40	50
010-140-55123	140 x 2" x 2"	40	50
010-160-55134	160 x 3/4" x 3/4"	40	50
010-160-55135	160 x 1" x 1"	40	50
010-160-55136	160 x 1 1/4" x 1 1/4"	40	50
010-160-55137	160 x 1 1/2" x 1 1/2"	40	50
010-160-55139	160 x 2" x 2"	40	50
010-200-55150	200 x 3/4" x 3/4"	30	40
010-200-55151	200 x 1" x 1"	30	40
010-200-55152	200x1 1/4" x 1 1/4"	30	40
010-200-55153	200x1 1/2" x 1 1/2"	30	40
010-200-55155	200 x 2" x 2"	30	40

• Dimensions des cartons

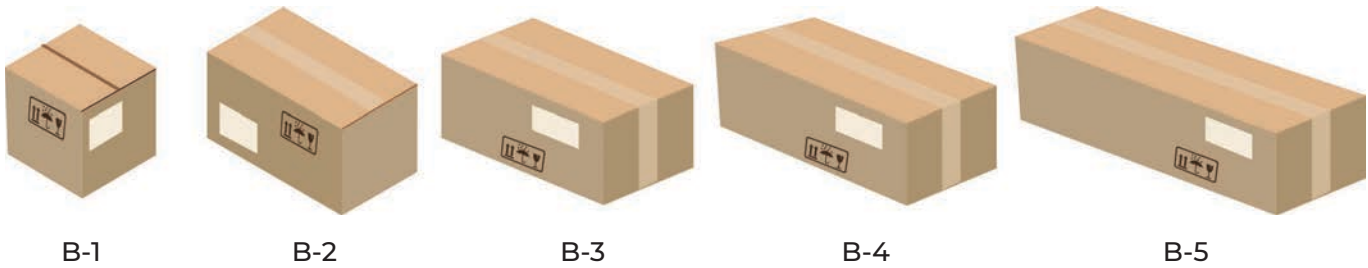

	type d'emballage	largeur	longueur	hauteur
		cm	cm	cm
	B-1	33	45	38
	B-2	46	65	44
	B-3	35	75	25
	B-4	35	95,5	25
	B-5	35	122	25
	S-1	55	105	30
	S-2	25	70	22
	S-3	35	80	22
	S-4	50	80	22

• Quantité de chargement

Type d'emballage	 20'' DC	 40'' DC	 40'' HC	 TRUCK
B-1	516	1056	1232	1470
B-2	225	450	540	630
B-3	450	920	1020	1170
B-4	348	730	800	924
B-5	256	548	600	715
S-1	210	420	470	520
S-2	750	1530	1836	2080
S-3	480	975	1170	1330
S-4	345	675	810	920



ZONE INDUSTRIELLE LOT
NO:105 LOCAL NO:01 - 22000
SIDI BEL ABBES



+213 0 48703190



altiminvest.com

